

# ROPER

TRACTOR AND ACCESSORIES



# THE SEASON VETERANS





ROPER TRACTORS ARE  
**THE SEASON.**





# VETERANS



MODEL L821	
ENGINE	BRIGGS & STRATTON
HORSEPOWER	8
DISPLACEMENT	19.4
IGNITION SYSTEM	KEY
CYLINDERS	1
FUEL TANK (CAPACITY)	4 <sup>9</sup> / <sub>4</sub> QTS
TRANSMISSION	4 SPEED TRANSAXLE
BATTERY	24 AMPS
FRONT TIRES	15. x 6.0
REAR TIRES	18. x 9.5
LENGTH	63"
WIDTH	48"
WEIGHT (APPROX)	354 lbs

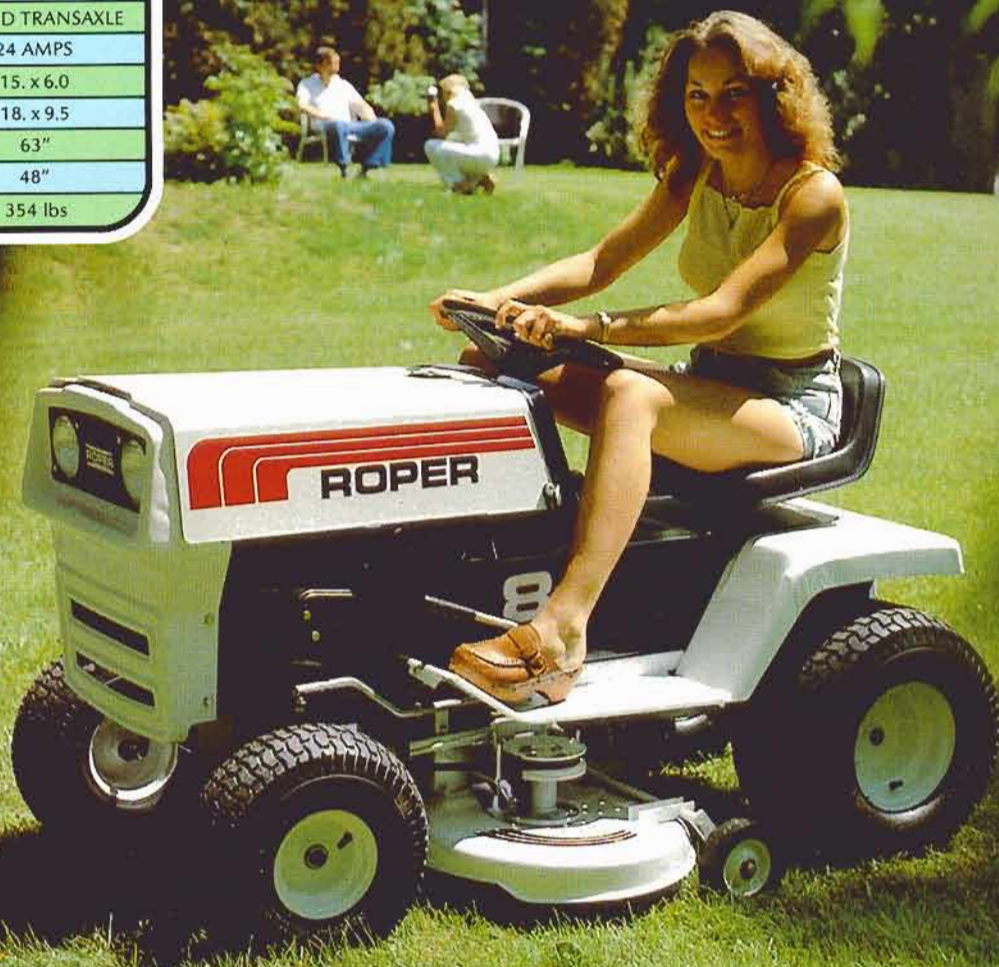

Smooth and easy lawn tractors

### Model L821 – 8 HP

Ample power and smooth handling puts lawn work behind you. Positive geared steering gives you precise control in tight places. Powered with an 8 horsepower Briggs & Stratton engine and transaxle drive with 3 forward speeds plus reverse. Cuts cleanly with a 36" dual blade mower with five cutting height adjustments. Standard features include electric starter, headlights, tail reflector, separate throttle/choke, 13" steering wheel, combination clutch/brake, separate parking brake, spring mounted seat and neutral interlock safety system.

**Tire Size:**

Front 15.0" x 6.0", Rear 18.0" x 9.5"

Wheel Base: 43.5"

Overall Length: 63", Overall Width: 48" (with deflector)

Overall Height: 40", Shipping Weight: 354 lbs.

**SPEED RANGE (APPROX. MPH)**

FIRST – 2.0

SECOND – 3.8

THIRD – 5.7

REVERSE – 2.7



MODEL L121	
ENGINE	BRIGGS & STRATTON
HORSEPOWER	11
DISPLACEMENT	23.7
IGNITION SYSTEM	KEY
CYLINDERS	1
FUEL TANK (CAPACITY)	4 <sup>3</sup> / <sub>4</sub> QTS
TRANSMISSION	4 SPEED TRANSAXLE
BATTERY	24 AMPS
FRONT TIRES	15.0 x 6.0
REAR TIRES	18 x 9.5
LENGTH	63"
WIDTH	48"
WEIGHT (APPROX)	394 lbs

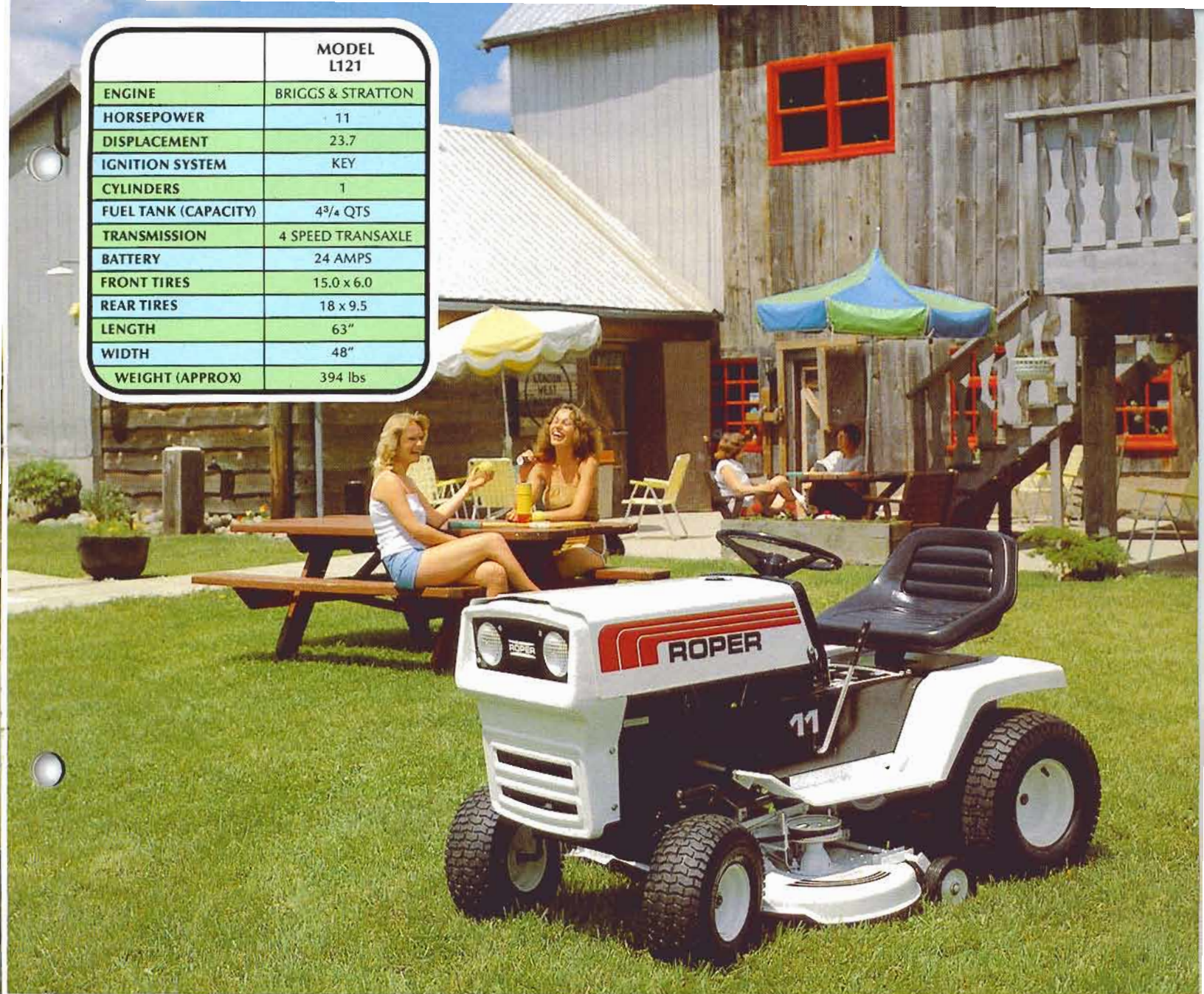

The great going lawn tractor

## Model L121 - 11 HP

Plenty of power, tight turn manoeuvrability puts you ahead with Roper positive geared steering. Powerful 11 horsepower Briggs & Stratton engine and transaxle drive with 3 forward speeds plus reverse. Complete with 36" dual blade mower with five adjustments for cutting height. Standard features include electric starter, headlights, tail reflector, separate throttle/choke, 13" steering wheel, combination clutch/brake, separate parking brake, spring mounted seat and neutral interlock safety system.

### Tire Size:

Front 15.0" x 6.0", Rear 18.0" x 9.5"

Wheel Base: 43.5"

Overall Length: 63", Overall Width: 48" (with deflector)

Overall Height: 40", Shipping Weight: 394 lbs.

### SPEED RANGE (APPROX. MPH)

FIRST - 2.0

SECOND - 3.8

THIRD - 5.7

FOURTH - 2.7



	MODEL T122
ENGINE	BRIGGS & STRATTON
HORSEPOWER	11
DISPLACEMENT	24.36
IGNITION SYSTEM	AUTOMOTIVE TYPE
CYLINDERS	ALUMINUM ALLOY
FUEL TANK (CAPACITY)	1 <sup>3</sup> / <sub>4</sub> GAL
TRANSMISSION	8 SPEED
BATTERY	42 PLATES
FRONT TIRES	16 x 6.50 x 8
REAR TIRES	23 x 7.50 x 12
LENGTH	63"
WIDTH	36.5"
WEIGHT (APPROX)	550 lbs.

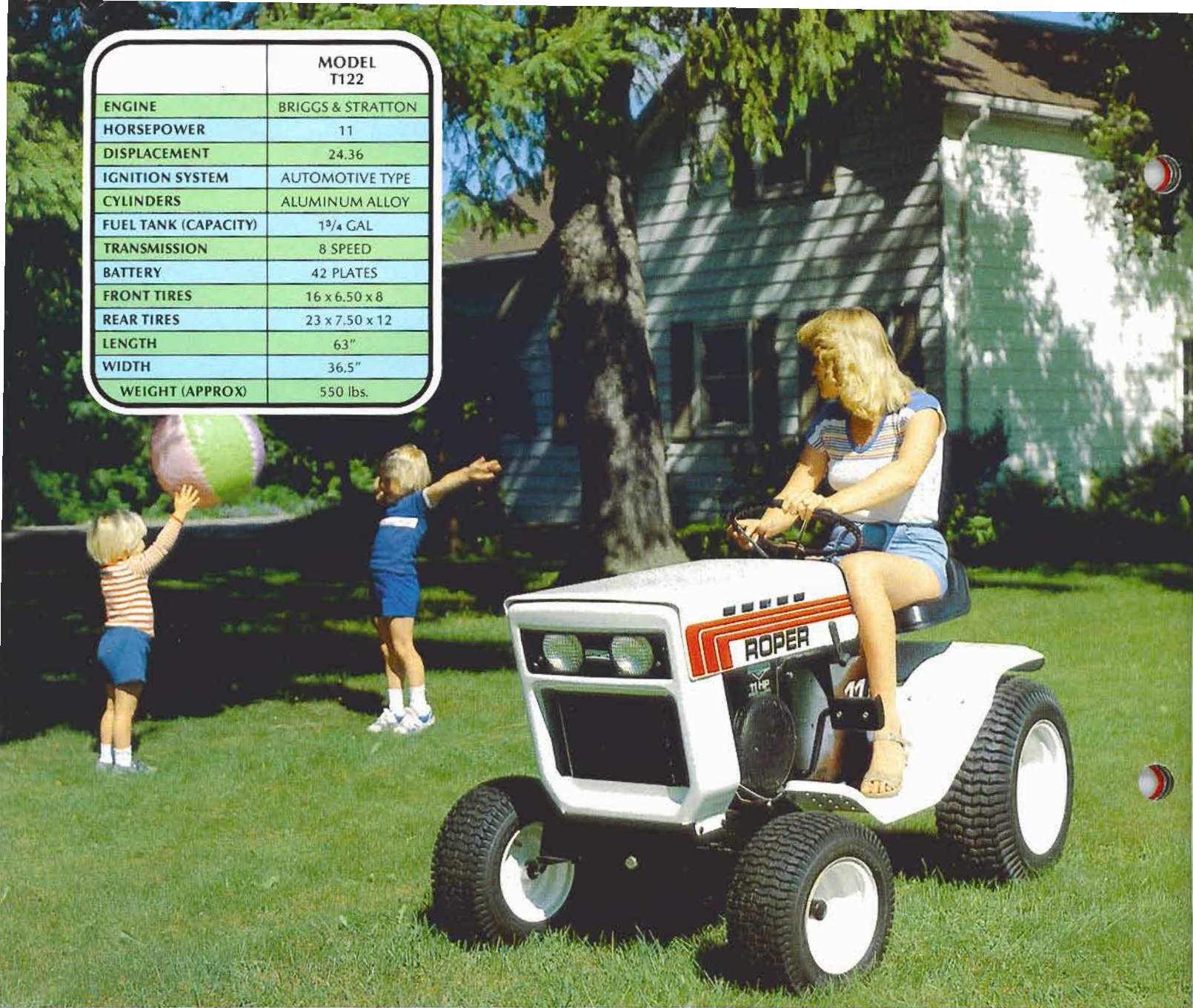

## Big performance garden tractor Model T122 – 11 HP

A smooth handling versatile tractor with big tractor performance. Rugged 11 horsepower Briggs Synchro-Balanced aluminum alloy engine with 6 forward and 2 reverse speeds that match the power to the task. The safety interlock system prevents starting until clutch lever is in neutral and attachment controls are disengaged. Combination foot operated clutch and brake, with lever operated parking brake, heavy duty battery. Dual spring adjustable seat, twin sealed beam headlights, tail-light and top fuel tank.

**Tire Size:**  
 Front 16" x 6.50 x 8, Rear 23" x 7.50 x 12"  
**Wheel Base:** 43"  
**Overall Length:** 63", **Overall Width:** 36.5"  
**Shipping Weight:** 550 lbs.



	MODEL T432
ENGINE	TECUMSEH
HORSEPOWER	14
DISPLACEMENT	23.70
IGNITION SYSTEM	SOLID STATE
CYLINDERS	CAST IRON
FUEL TANK (CAPACITY)	TOP 1 <sup>3</sup> / <sub>4</sub>
TRANSMISSION	8 SPEED
BATTERY	54 PLATES
FRONT TIRES	16 x 6.50 x 8
REAR TIRES	23 x 7.50 x 12
LENGTH	63"
WIDTH	36.5"
WEIGHT (APPROX)	570 lbs.



The easy-handler garden tractor

## Model T432 – 14 HP

Great going and easy handling with the power you need. Tecumseh 14 horsepower cast iron engine with solid state ignition system with the 8 speed all-gear Roper 6 + 2 Pac power train transmission for the right pull for the job. Separate throttle/choke, keystart, top fuel tank with visual level indicator, independent parking brake, combination clutch/brake, headlights, tail-light.

**Tire Size:**

Front 16" x 6.50 x 8", Rear 23" x 7.50 x 12"

Wheel Base: 43"

Overall Length: 63", Overall Width: 36.5"

Shipping Weight: 570 lbs.



	MODEL T632
ENGINE	BRIGGS & STRATTON
HORSEPOWER	16
DISPLACEMENT	40.0
IGNITION SYSTEM	HIGH TENSION MAGNETO
CYLINDERS	2 CAST IRON SLEEVES
FUEL TANK (CAPACITY)	3 1/2 GAL
TRANSMISSION	8 SPEED
BATTERY	66 PLATES
FRONT TIRES	16 x 6.50 x 8
REAR TIRES	23 x 9.50 x 12
LENGTH	65"
WIDTH	36.5"
WEIGHT (APPROX)	625 lbs.



An all-round performer garden tractor

### Model T632 – 16 HP

Powered and ready to handle the tough jobs with a Briggs & Stratton 16 horsepower twin cylinder cast iron engine. High tension magneto ignition system for fast sure starting. Six forward, 2 reverse speeds that match power to the task. Heavy duty 66 plate battery. Neutral interlock systems prevents starting until clutch lever is in neutral and attachment controls are disengaged. Extra wide tires distribute weight to protect the lawn and provide a smooth ride. Rear mounted fuel tank for easier filling – eliminates possibility of spillage on hot engines. Combination foot operated parking brake.

**Tire Size:**  
**Front 16 x 6.50 x 8", Rear 23" x 9.50 x 12"**  
**Wheel Base: 43"**  
**Overall Length: 65", Overall Width: 36.5"**  
**Turning Radius: 35" inside, Shipping Weight: 625 lbs.**



MODEL T832	
ENGINE	ONAN
HORSEPOWER	18
DISPLACEMENT	48.0
IGNITION SYSTEM	AUTOMOTIVE TYPE
CYLINDERS	2 CAST IRON SLEEVES
FUEL TANK (CAPACITY)	3 1/2 GAL
TRANSMISSION	8 SPEED
BATTERY	66 PLATES
FRONT TIRES	16 x 6.50 x 8
REAR TIRES	23 x 9.50 x 12
LENGTH	65"
WIDTH	36.5"
WEIGHT (APPROX)	656 lbs.



## The Little Giant Garden Tractor Model T832 – 18 HP

Onan twin opposed piston, four cycle twin cylinder, 18 horsepower engine runs quietly, runs smoothly, far less vibration than virtually all single cylinder engines. 8 speed all gear transmission provides ground speeds that match power to the task. Six forward speeds. .85 MPH to 6.56 MPH, two reverse speeds 1.02 MPH to 2.53 MPH, neutral interlock systems prevent starting until clutch lever is in neutral and attachment controls are disengaged. Combination foot operated clutch and brake with lever operated parking brake. Extra wide tires distribute weight to protect the lawn and provide a smooth ride. Keyswitch electric start, running time monitor, twin sealed beam head-

lights, full fenders and footrests, tail-light and deep padded, high back, spring mounted adjustable seat are just some of the standard features.

**Tire Size:**  
**Front 16" x 6.5 x 8", Rear 23" x 9.50 x 12"**  
**Wheel Base: 43"**  
**Overall Length: 65", Overall Width: 36 1/2"**  
**Turning Radius: 35" inside, Shipping Weight: 656 lbs.**

### Roper 6 + 2 Pac Power Train

LOW RANGE			HIGH RANGE			REVERSE	
1ST	2ND	3RD	1ST	2ND	3RD	LOW	HIGH
.85	1.60	2.56	2.10	3.96	6.56	1.02	2.53



	MODEL T932
ENGINE	ONAN
HORSEPOWER	20
DISPLACEMENT	52.2
IGNITION SYSTEM	AUTOMOTIVE TYPE
CYLINDERS	2 CAST IRON SLEEVES
FUEL TANK (CAPACITY)	3 1/2 GAL
TRANSMISSION	8 SPEED
BATTERY	66 PLATES
FRONT TIRES	16 x 6.50 x 8
REAR TIRES	23 x 10.50 x 12
LENGTH	65"
WIDTH	36.5"
WEIGHT (APPROX)	656 lbs.



## The big job master garden tractor Model T932 – 20 HP

For the balance of weight and power to get the big jobs done, this newest addition to our tractor line is the master. Rugged 20 horsepower Twin Cylinder Onan Engine. Will handle any job you have. 8 speed all gear transmission provides ground speeds that match power to the task. Six forward speeds, .85 MPH to 6.56 MPH, two reverse speeds 1.02 MPH to 2.53 MPH, neutral interlock systems prevent starting until clutch lever is in neutral and attachment controls are disengaged. Combination foot operated clutch and brake with lever operated parking brake. Extra wide tires distribute weight to protect the lawn and provide a smooth ride. Keyswitch electric start, running time monitor, twin sealed beam headlights, full fenders and footrests,

tail-light and deep padded, high back, spring mounted adjustable seat are just some of the standard features.

### Tire Size:

Front 16" x 6.5 x 8", Rear 23" x 10.5 x 12"

Wheel Base: 42"

Overall Length: 65", Overall Width: 36 1/2"

Turning radius: 35" inside, Shipping Weight 656 lbs.

### Roper 6 + 2 Pac Power Train

LOW RANGE			HIGH RANGE			REVERSE	
1ST	2ND	3RD	1ST	2ND	3RD	LOW	HIGH
.85	1.60	2.56	2.10	3.96	6.56	1.02	2.53





# Roper big tractor features for big tractor performance



## Dual Air Filter System

Donut-shaped, pre-cleaner foam fits snugly over standard filter element to provide double protection. Increases engine efficiency.



## Hour Meter

Service Hour Meter on dash keeps accurate operation time. Tells you when to perform necessary servicing. Available on 18 and 20 H.P. tractors. See Owner's Manual.



Left Panel, Top to Bottom

## Roper 6 + 2 Pac Power Train

Rugged Roper-built all-gear transmission provides 6 precise speeds forward from .85 to 6.56 mph., plus 2 reverse speeds of 1.02 and 2.53 mph.

## Easy Speed Selection

With Roper two speed ranges, you can match tractor power to mowing conditions. Gear down to drive the tractor slowly in tall grass. Gear up to run faster across an average lot. And still deliver full-power to the mowing attachment. Equally great performance and dependable power for tilling, grading and snow removal.

## Adjustable Tie Rods

Automotive type allows adjustments to maintain easy steering. Properly adjusted tie rods eliminate "wandering", helps return to straight ahead after turning.



## Hydraulic Loader Attachment

### Model LRO - 100 - 73

Removing snow from your driveway or hauling manure from inside your barn... these and other back breaking chores are done easily and quickly with this ROPER-LOADER-COMBINATION. For town and country places the big loaders won't go: In Parks; Motels; Elevators; at Home; Nurseries; Industrial Plants and by Contractors.

### Self Levelling Feature: Keeps loads in bucket level at all times.

Your Roper Loader Attachment is ruggedly built. It provides the lowest cost, most compact and manoeuvrable material handling unit available for compact tractors. This loader comes complete with its own hydraulic system.

For increased safety and stability, we strongly recommend wheel weights and dual wheels with spacer kits.



#### LOADER SPECIFICATIONS

The dimensions as shown below are:

A-8'2" B-49" C-50" D-72" E-60" F-26 1/2"

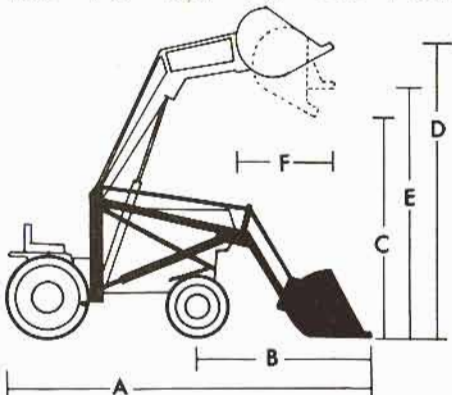

Dimension will vary with tractor model.

**On the farm or in your  
yard... you're ridin' high  
with Roper Attachments**



## 40" Disc Harrow TT42

(Requires TA20)

Double gang of 12" high-carbon steel discs can be set in three different positions; cut up trash, break up dirt clods, level and pulverize soil after plowing.



## 10" Plows TT41

(Requires TA20)

Plow a furrow up to 6" deep, 8" wide; 10" plow for 11, 14, 16 H.P., 18 H.P. and 20 H.P. tractors.



## Self Powered 8 H.P. Roto-Tiller TT50

(Requires TA20)

8 H.P. engine drives tiller at constant speed allowing 11" diameter tines to til up to 6" depth with 36" cut. Less jumping and bucking. Non-clogging tines, gauge wheels. Provides excellent garden seed bed preparation.  
(If mounted with electric 3 PT Hitch requires TA188 Lift Link Kit)





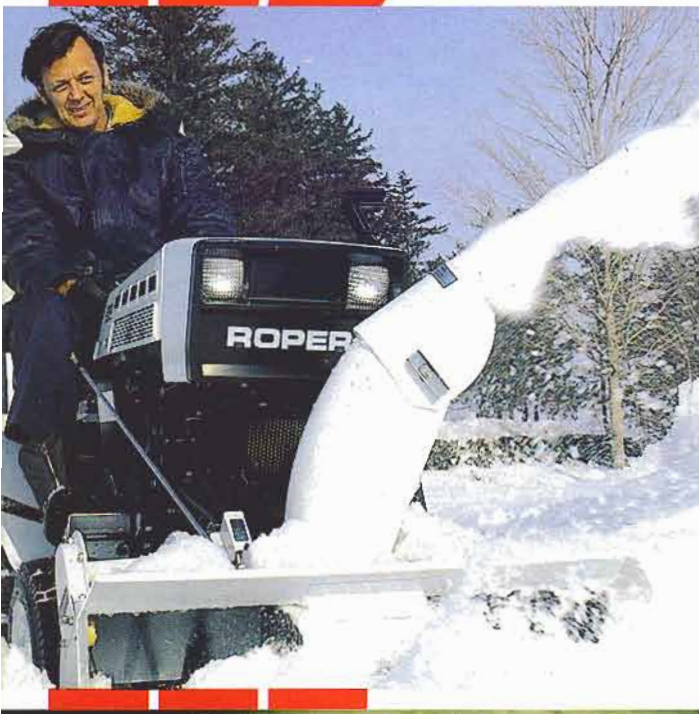

# Roper accessories give you all-season, all- versatility.

## Snow Blower (TT64) LAO4 (TT67)

(Tire chains and wheel weights recommended)

Whip the worst of winter's weather the easy way. Powerful rotary snow throwers have a unique heavy-duty auger with four discharge paddles. Throws snow forward, left or right. Discharge chute is controlled by worm rotating mechanisms from driver's seat.

Available in 42" width for 16 H.P. and 18 H.P. and 20 H.P. tractors. 40" width for 11 H.P. and 14 H.P.

36" width for 8 H.P. and 11 H.P. lawn tractor.



## Three Blade Rotary Mower

Wide-swath mowing from 1.5" to 4.5" scissor mounting and parallel-float, spring loaded snap-pin installation.

Model - TT72 42" for 16 H.P.

Model - TT72 42" for 18 H.P.

Model - TT72 42" for 20 H.P.

Model - TT73 48" for 16 H.P.

Model - TT73 48" for 18 H.P.

Model - TT73 48" for 20 H.P.

Model - TT71 42" for T122 and T432

## 46" Dozer Blade TT74

Move the snow out of your way quickly, easily... use for levelling and grading dirt or gravel. Free-floating blade can be angled left or right (2 left, 2 right, 1 centre position), raised or lowered from driver's seat. Heavy steel blades and adjustable skid shoes. 46" blade for 11 H.P., 14 H.P., 16 H.P., 18 H.P. and 20 H.P.

Mounting Bracket for Blade

TT75 for 11 H.P. & 14 H.P.

TT76 for 16 H.P., 18 H.P. and 20 H.P.



## Dump Carts 755 - 10

Rugged, all steel carts 'Tote-around' a lot of flowers, fertilizer, soil, compost, gardening tools, lawn debris... or load them with firewood. Pneumatic tires take it easy on the lawn. Quick hook-up to tractor drawbar. Dump easily with back 'gate' removed. 10 cu.ft. capacity.





reason

(Top Left):

### Rear Wheel Weights

Add 70 pounds for improved traction with snow throwing and plowing attachments. Two sets may be used for even greater traction.

Model - TA0231 All Models

(Below):

### 40" Sickle-Bar Mower TT263

Attaches easily with one bolt and two spring pins... cuts over one acre per hour in tall grass and weeds.

For 16 H.P., 18 H.P. and 20 H.P. tractors only.



### Tractor Tri-Hitch TA20

This heavy duty Tri-Hitch pulls attachments at proper angles for best performance. Designed for use with Roper tractors, provides a proper line of draft equivalent to hooking up attachment beneath centre of tractor. Tri-Hitch mounts on tractor drawbar with four bolts. Attachments are mounted in less than thirty seconds with three snap pins (no tools needed). Over-centre lift lever permits easy raising and lowering of

attachments from driver's seat. Turn buckles for quick depth and levelling adjustments. Also available TA15 Electric Tri-Hitch.



### Grader Leveller Blade TT49

(Requires TA20)

For levelling soil, grading lanes, driveways, etc. 42" blade attaches easily to Tri-Hitch with only three snap pins. Tilt and angle of blade is adjustable. Can be used with Roper bulldozer on front of tractor for maximum efficiency.



### Adjustable Cultivator TT463

(Requires TA20)

All models handle rows from 20" to 30" wide or cultivate between rows of 36" or more. Five tempered shanks and five 6" sweeps.

#### Tire Chains for Tractors

TA113 for 11 H.P.  
TA123 for 16 H.P.  
TA123 for 18 H.P.  
TA123 for 20 H.P.



## Attachment Selection for Roper Tractors

MODEL	42" ROTARY MOWER TT71	42" ROTARY MOWER TT72	48" ROTARY MOWER TT73	70" PLOW TT41	40" DISC HARROW TT42	CULTIVATOR TT463	42" REAR GRADER BLADE TT49	38" 8 HP TILLER TT50	46" DOZER BLADE TT74	36" SNOWTHROWER TT67	39" SNOWTHROWER TT64	MANUEL 3 PT HITCH TA20	ELECT 3 PT HITCH TA15	REAR WHEEL WEIGHTS TA0231	DUMP CART 755-10	FRONT END LOADER LRO-100-73	TIRE CHAINS (8.50 x 12) TA113	TIRE CHAINS (9.50 x 12) TA123	TIRE CHAINS (10.50 x 12) TA123	ORGANIC SHREDDER 763-10	SNOWTHROWER L404	SICKLE-BAR MOWER TT263	
L821															•							•	
L121															•							•	
T122	•				•	•	•	•	•		•	•	•	•	•		•						
T432	•				•	•	•	•	•		•	•	•	•	•		•						
T632		•	•	•	•	•	•	•	•		•	•	•	•	•	•		•		•			•
T832		•	•	•	•	•	•	•	•		•	•	•	•	•	•			•	•			•
T932		•	•	•	•	•	•	•	•		•	•	•	•	•	•			•	•			•

**ROPER** OUTDOOR POWER PRODUCTS

1905 West Court Street  
Kankakee, Illinois 60901

WEST SIDNEY GARAGE  
R.F.D. 4  
BUSTON, MAINE 04330

PRINTED IN CANADA



## Roper Tri-Hitch

This heavy-duty Tri-Hitch pulls attachments at proper angles for best performance. Designed for use with Roper Tractors, provides a proper line of draft equivalent to hooking up attachment beneath center of tractor. Tri-Hitch mounts on tractor drawbar with four bolts. Attachments are mounted in less than sixty seconds with three snap-pins (no tools needed). Turnbuckles for quick depth and leveling adjustments.

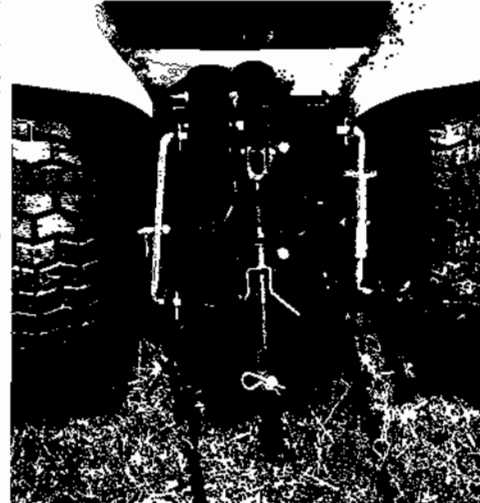
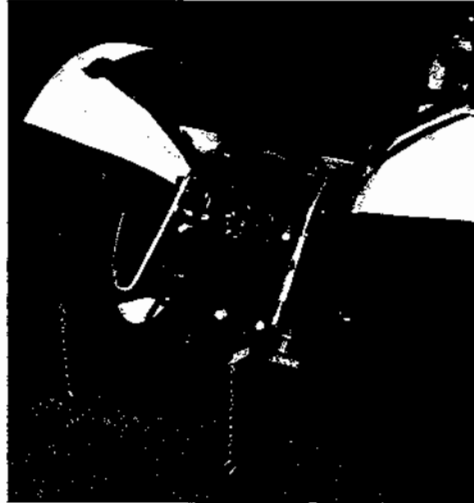

### 1. Manual Tri-Hitch TA207AR, TA1331R

Over-center lift lever permits easy raising and lowering of attachments from driver's seat. TA1331R for 8 and 10 hp tractors only.

### 2. Lectro-Lift TA157AR

Electric-powered lift does all the work for you . . . handles heaviest attachments easily . . . operates with toggle-switch on dash. For all Roper tractors.

### 3. 8 and 10-inch Plows\*\* TT4031R, TT418R

Plow a furrow up to 6 inches deep, 8 inches wide. 8-inch plow for Roper 8, 10, 11 and 14 hp tractors. 10-inch plow for 13, 16 and 18 hp tractors.

### 4. 40-inch Disc Harrow\*\* TT4241R

Double gang of 12-inch high-carbon steel discs can be set in three different positions; cut up trash, break up dirt clods, level and pulverize soil after plowing.

### 5. 40-inch Drag Harrow\*\* TT4331R

Tooth spacing is staggered for full soil contact every 1-7/8" across full 40-inch working area. 4 positions for angling teeth for desired tilling depth; for leveling, pulverizing breaking clods and preparing an extra fine seed bed.

### 6. Adjustable Cultivator\*\* TT4631R

Handles rows from 20 to 30 inches wide or cultivates between rows of 36 inches or more. 5 tempered shanks and five 6" sweeps. Kit available with 2 weed hoes and 2 hilling tools.

### 7. Seeder Fertilizer\*\* TT5251R

One operation vegetable planter opens furrow, drops seed, fertilizes and covers seed in one fast operation. Patented seeding mechanism handles all sizes of seeds. Plant your garden and fertilize your seeds in one easy operation.

### Self-powered Roto-Tillers\*\*

Power-packed engines drive tiller at constant speed allowing 11" diameter tines to till up to 6" in depth . . . less jumping and bucking. Non-clogging tines, gauge wheels. Provide excellent garden seed bed preparation.

### 8. 8 hp Roto-Tiller TT508AR . . . 38" cut.

### 9. 6 hp Roto-Tiller TT518AR . . . 30" cut.

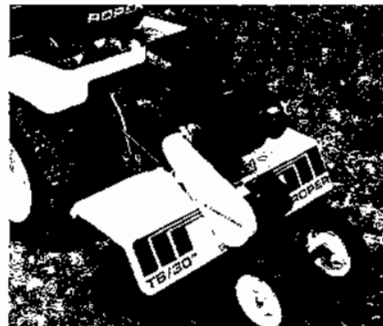
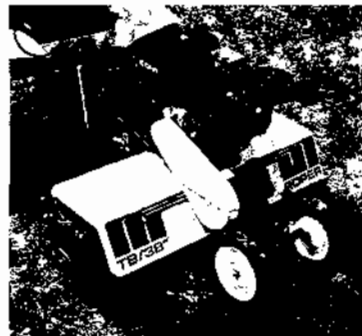
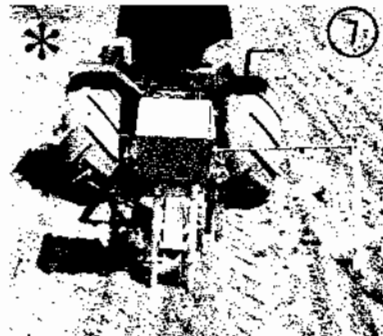
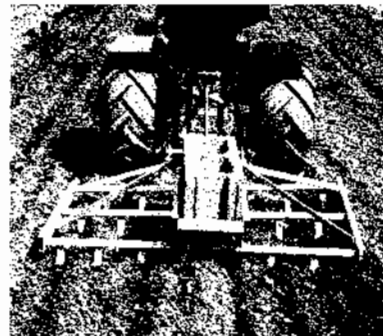
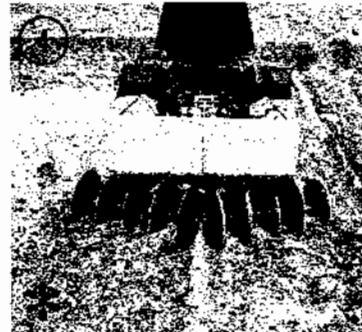
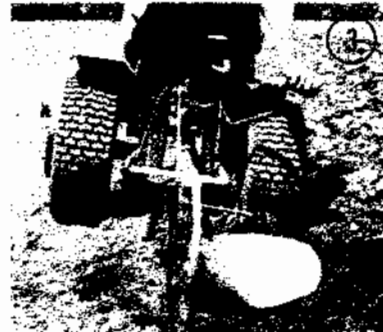

\* Tractors shown with optional 10:50 Agricultural tread tires.

\*\* These Roper Attachments require TA1331R, TA207AR or TA157AR.



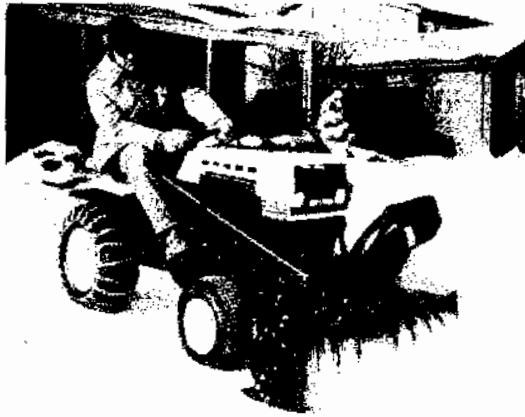

### Snow Blower TT6231R (35-inch) TT648AR (39-inch) (the tire chains and wheel weights are recommended)

Whip the worst of winter's weather the easy way. Powerful rotary snow throwers have a unique heavy-duty auger with four discharge paddles. Throws snow forward, left, or right. Discharge chute is controlled by worm rotating mechanism from driver's seat. Available in 35-inch width models for Roper 8 & 10 hp only. The 39-inch width for 13, 16 and 18 hp Tractors.



### 46-inch Dozer Blade TT748AR

Move the snow out of your way quickly, easily . . . use for leveling and grading dirt or gravel. Free-floating blade can be angled left or right (2 right, 2 left, 1 center positions), raised or lowered from driver's seat. Heavy-steel blades have replaceable cutting edge and adjustable skid shoes. For 11, 13, 14, 16 and 18 hp Roper garden tractors. Requires front-mounting bracket: TT758AR (11 and 14); TT768AR (13, 16 and 18).



### Power-Vacuum TT6951R

Clean, clear lawns the easy way . . . Power-Vacuum collects clippings or fall leaves in a big rear bag. Rear zipper permits easy removal of heavy-duty plastic bag for dumping . . . easily replaced for new load. For all Roper tractors.

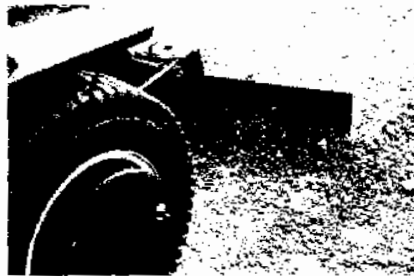

### Grader-Leveler Blade TT498AR (requires TA1331R, TA207AR or TA157AR)

For leveling soil, grading lanes, driveways, etc. 42-inch Blade attaches easily to Roper Tri-Hitch with only three snap pins. Tilt and angle of blade is adjustable. Can be used with Roper bulldozer blade on front of tractor for maximum efficiency.

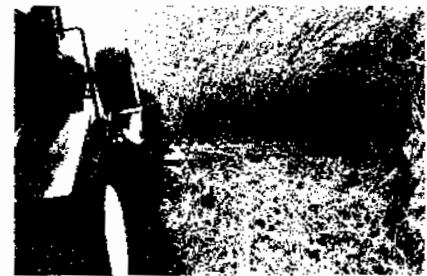

### 40-inch Sickle-Bar Mower TT2631R

Attaches easily with one bolt and two spring pins . . . cuts over one acre per hour in tall grass and weeds. For Roper 13, 16 and 18 hp Tractors only.

## ATTACHMENT SELECTION FOR ROPER TRACTORS

MODEL	38" Rotary Mower TT2041R	42" Rotary Mower TT718AR	42" Rotary Mower TT728AR	42" Rotary Mower TT2131R	48" Rotary Mower TT2231R	48" Rotary Mower TT738AR	40" Sickle Bar TT2631R	38" Power Sweeper TT3042R	8" Plow TT4031R	10" Plow TT418R	40" Disc Harrow TT4241R	40" Drag Harrow TT4331R	Middlebuster Plow TT4431R	Cultivator TT4831R	42" Rear-grader Blade TT498AR	38" 8 hp Tiller TT508AR	30" 6 hp Tiller TT518AR	Seeder Fertilizer TT5251R	46" Dozer Blade TT748AR	35" Snow Thrower TT6231R	39" Snow Thrower TT648AR	Vacuum Collector TT6951R	Manual 3-point Tri-Hitch TA1331R	Manual 3-point Tri-Hitch TA207AR	Lectro-Lift TA157AR
T8328AR			●	●	●	●	●	●		●	●	●	●	●	●	●	●	●	●	●	●		●	●	●
T63361R			●	●	●	●	●	●		●	●	●	●	●	●	●	●	●	●	●	●		●	●	●
T6328AR			●	●	●	●	●	●		●	●	●	●	●	●	●	●	●	●	●	●		●	●	●
T63241R			●	●	●	●	●	●		●	●	●	●	●	●	●	●	●	●	●	●		●	●	●
T62241R			●	●	●	●	●	●		●	●	●	●	●	●	●	●	●	●	●	●		●	●	●
T32241R			●	●	●	●	●	●		●	●	●	●	●	●	●	●	●	●	●	●		●	●	●
T4328AR		●																							
T1228AR		●																							
T02251R	●																								
T82251R	●																								

For maximum traction and performance, tractor wheel weights are recommended with tillage and snow removal equipment.





# Sears TRACTOR ATTACHMENTS

help your riding tractor tackle those tough or time-consuming tillage, lawn care and snow removal jobs.

## LAWN CARE ATTACHMENTS

### TRAILING LAWN SWEEPERS

Lawn clippings, leaves, picked-up easily, quickly without raking. Rear mount. Removable vinyl basket. 30-in. or 36-in.

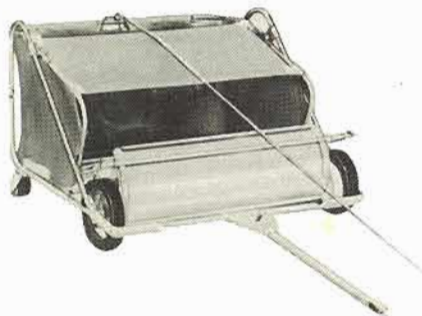

### LAWN ROLLERS

Smooths surfaces, rolls seed or sod. 36-in. steel cylinder 89-lbs. empty, add water for up to 390 lbs.



### POWER SPRAYER AND BOOM

3-HP sprayer delivers 300-lbs. pressure per sq. inch. Comes with spray gun, hose. Spray boom assembly available.

### LAWN VACUUM

3-HP engine for fast clean-up. Detachable bag holds up to 125 lbs. of clippings. Optional hand wand attachment, other lawn vacuums available.

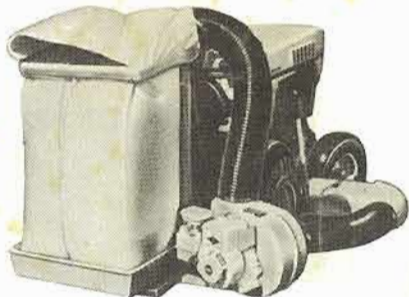

### AERATOR

Steel spikes punch hundreds of holes. Lets soil "breathe". Moisture, fertilizer have access to roots for healthy lawn.



### HAULING CARTS

18 cu. ft. cart holds up to 1500 lbs. Self-locking trip latch, lift out end gate for easy dump. Other carts available.

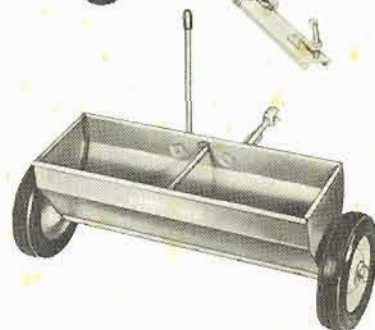

### SPREADERS

36 in. 100 lb. capacity spreader-seeder (right). 80 lb. broadcast spreader (left) spreads 5 to 8 ft. wide area. 40 lb. broadcast spreader (not shown).

### GRADER AND LEVELER BLADE

Levels and grades many surfaces. 42-in. wide, 9-in. high blade. Adjusts from straight to angles of 17°, 34° right or left. Rear mounting.

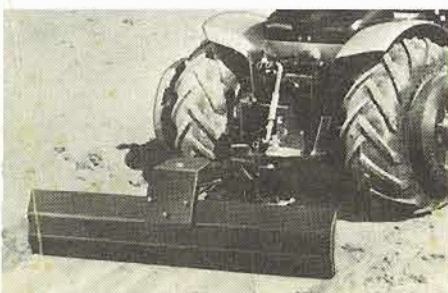

### HYDRAULIC LOADER

Hydraulic dual double action cylinders. Self leveling linkage keeps bucket level. Lifts to 79-in. high, 500 lb. capacity.





# ATTACHMENTS CAN HELP MAKE THE JOB EASY

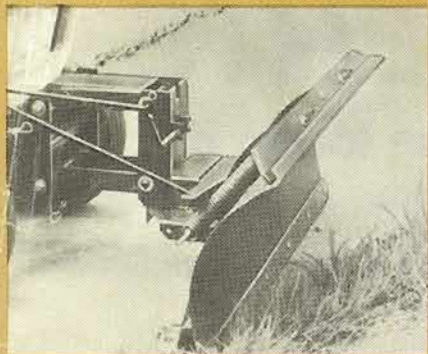

## SNOW REMOVAL ATTACHMENTS

Snow Throwers handle wet, heavy or powdery snow quickly. Stop and start clutch and chute are controlled from operator's seat. Skid shoes adjust height to suit ground surfaces. Throwers available for all Sears garden tractors and some lawn tractors.

Snow Cab helps protect operator from wind, cold, blowing snow. Windows provide 360° visibility. Cab has white fiber glass top and durable vinyl windshield. Amber light and glass windshield are optional.

Heavy-duty tire chains and wheel weights\* for added traction are also available.



## ALSO AVAILABLE

Dozer and Snow blades. Steel blades angle left or right. Raise or lower from tractor seat.

## TILLAGE ATTACHMENTS for garden tractors

### 3-PT. HITCHES

Hitches connect rear-mount attachments to all Sears garden tractors. Choose from electrical power lift or manual hitch.

### 8-HP ROTO TILLER

Cultivates, prepares soil for seeding. Eight 11-in. diameter tines powered by 8-HP engine. Cuts 38-in. wide swath. Manual start.

### 10-INCH PLOW

Turns soil to 6-in. depth. Soft-center, hard-tempered moldboard and share help prevent sticking and soil build-up.

### DISC HARROW

Breaks clods, cuts trash, pulverizes after plowing. Two gangs of 12-in. steel discs, 5-in. apart. Angles 3 positions.

### DRAG HARROW

Levels, pulverizes, prepares fine seed bed after discing. Teeth spaced for soil contact every 2-in. Cuts 40-in. swath.

### PLANTER-FERTILIZER

In one operation opens furrow, plants, covers, fertilizes seeds, marks next row. Direct drive chain. 7-sprocket speeds.

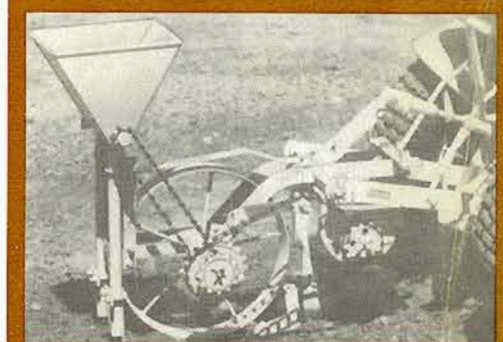
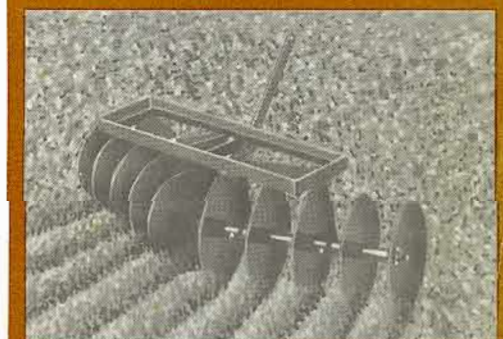
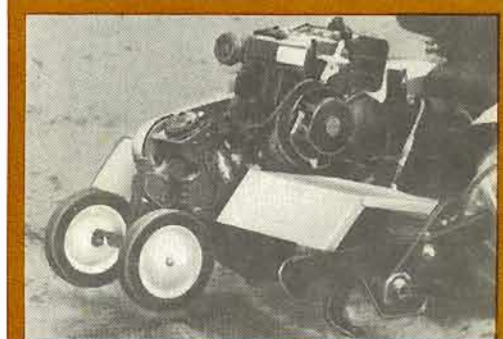
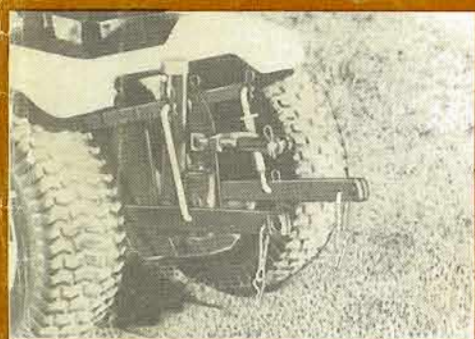

Wheel weights are recommended with many of these attachments for maximum efficiency, traction and counter-balance.

Ask about Sears credit plans  
 © SEARS, ROEBUCK AND CO., 1979  
 Satisfaction Guaranteed or Your Money Back

Available at most Sears stores or order from catalog

Printed in U.S.A. 12/79 FF32-87677